



Sinks

VC 815A

CUBE COLLECTION

Design Wetstyle Design Lab



FEATURES

Handcrafted in Montreal, Canada

Installation type: above-counter

Available with or without overflow

Overflow trim finish options: polished chrome, brushed nickel, matte black, satin brass or no metallic trim

TECHNICAL DETAILS

- **Width:** 15"
- **Length:** 15"
- **Height:** 4.25"
- **Weight:** 14 lbs / 6 kg

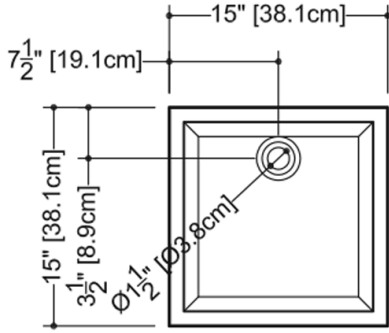

plan view

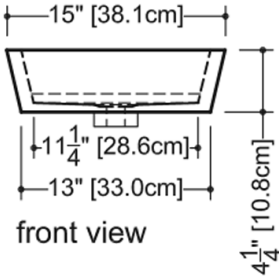

front view

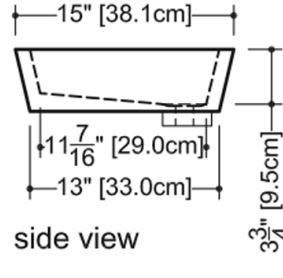

side view

VC 815A

WETSTYLE cannot be held responsible for any technical errors and reserves the right to make revisions without notice. Approximate measurement. The manufacturer accepts 1/4" (6.35mm) variance.

OPTIONS

Model

- VC815A

Overflow

- No Overflow
- With Overflow - Brushed Nickel (#BN)
- With Overflow - Matte Black (#MB)
- With Overflow - No Trim (#NT)
- With Overflow - Polished Chrome (#PC)
- With Overflow - Satin Brass (#SB)

WETMAR BiO Finish

- White Matte (#MA)
- White True High Gloss (#GA)

CODES/STANDARDS APPLICABLES

IAPMO-ANSI Z124.1
IAPMO-ANSI Z124.3
CSA B 45.0
CSA B 45.4
Mass Board Approved