

23-2.2S-L8

Wall Mounted 3 Hole Lavatory Set

Flow Rate: 1.2 GPM

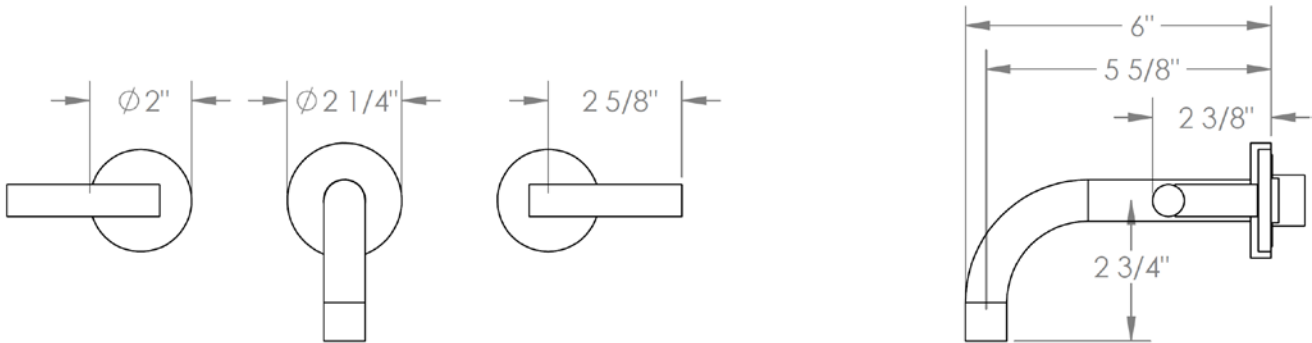

Meets the applicable requirements of ASME A112.18.1-2005/CSA B125.1-05, entitled "Plumbing Supply Fittings"