

Features

- Multifunction handshower offers full coverage and targeted massage spray settings
- Ergonomic design is comfortable and easy to grip
- MasterClean™ sprayface features an easy-to-clean surface that withstands mineral buildup
- 1.75 gpm (6.6 lpm) flow rate.
- Contains flow-regulating check valve for backflow prevention
- This product can help a building earn Water Efficiency points in LEED® Green Building Rating System

Required Products/Accessories

K-8593 72" Shower Hose
K-9069 24" shower slidebar

or

K-9069 24" shower slidebar
K-9514 60" Shower Hose

or

K-14791 wall-mount handshower holder with supply elbow
K-8593 72" Shower Hose

or

K-14791 wall-mount handshower holder with supply elbow
K-9514 60" Shower Hose

or

K-14789 deck- or bath-mount handshower holder with hose

Recommended Products/Accessories

K-23723 Faucet cleaner

Optional Products/Accessories

K-9660 Vacuum Breaker



OBC

Codes/Standards









ASME A112.18.1/CSA B125.1
DOE - Energy Policy Act 1992
EPA WaterSense®
California Energy Commission (CEC)
OBC

KOHLER® Faucet Lifetime Limited Warranty

See website for detailed warranty information.

Available Colors/Finishes

Color tiles intended for reference only.

Color	Code	Description
	CP	Polished Chrome
	SN	Vibrant® Polished Nickel
	BN	Vibrant® Brushed Nickel
	BV	Vibrant® Brushed Bronze
	2BZ	Oil-Rubbed Bronze
	BL	Matte Black
	2MB	Vibrant® Brushed Moderne Brass
	TT	Vibrant Titanium

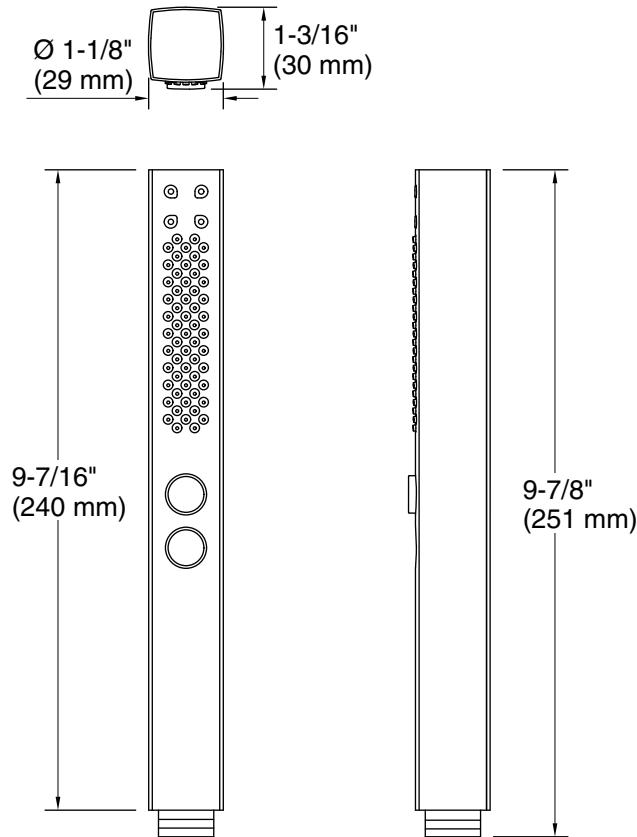

Technical Information

All product dimensions are nominal.

Drain included: No

Handshower:

Rated maximum flow: 1.75 gal/min (6.6 l/min)

Pressure: 80 psi (5.5 bar)

Notes

For use with automatic compensating valves rated at 1.5 gal/min (5.7 l/min) or less.

Install this product according to the installation instructions.

Plumbing codes may require that a vacuum breaker be installed in-line to handshowers.

Please consult local plumbing codes.

OBC compliant when installed to the specific requirements of these regulations.