

Features

- Single-speed whirlpool offers performance and value, with 6 fully adjustable jets.
- Hydromassage flow and direction can be controlled at each jet.
- Generous 6-foot length provides an incredibly spacious bathing area.
- Hourglass shape adds style and elegance to your bathroom.
- Textured bottom surface
- Multiple pump location options give you more choices for installation and access. (See specification sheet for pump locations.)

Material

- Acrylic

Hydrotherapy

- Whirlpool

Installation

- Drop-in

Recommended Products/Accessories

K-1283 Removable Apron
K-1491 Bath/Whirlpool Pillow
K-7166-AF Bath Drain
K-9696 Whirlpool 6-Jet Trim Kit
K-24916 Wireless Music Kit
K-1601 Bath/Whirlpool Footstop
K-7213 27" Cable Bath Drain
K-7214 27" Cable Bath Drain
K-7259 Clearflo Bath Drain



Codes/Standards

ASME A112.19.7/CSA B45.10
CSA B45.5/IAPMO Z124
ASTM E162
ASTM E662
UL 1795





**KOHLER® Plastic Baths and Receptors
Lifetime Limited Warranty
KOHLER® Hydrotherapy Components
Five-Year Limited Warranty**

See website for detailed warranty information.

Available Colors/Finishes

Color tiles intended for reference only.

Color	Code	Description
-------	------	-------------

	0	White
	96	Biscuit
	47	Almond
	NY	Dune
	G9	Sandbar

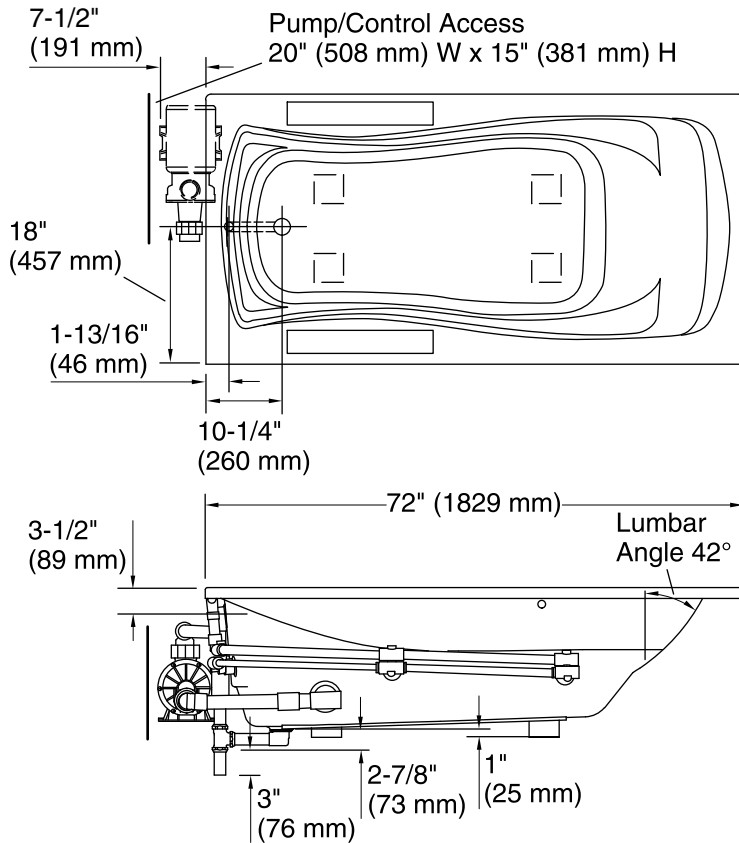

No change in measurements if connected with drain illustrated. (K-7161-AF)

□ Recommended Faucet Location

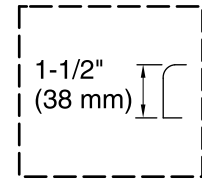

Drop-in Rim Detail

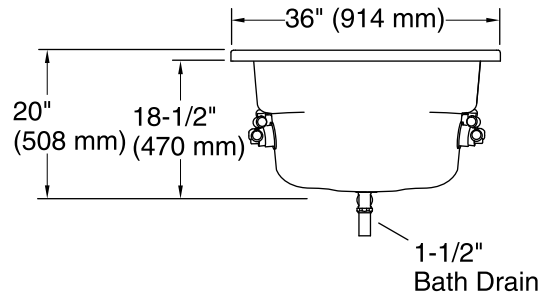

Required Electrical Service

One dedicated circuit required, protected with Class A Ground-Fault Circuit-Interrupter (GFCI). Outside North America, this device may be known as a Residual Current Device (RCD).

Pump: 120 V, 15 A, 60 Hz

Technical Information

All product dimensions are nominal.

Installation: Drop-in
 Drain location: End
 Basin area, bottom: 50" x 24" (1270 mm x 610 mm)
 Basin area, top: 65" x 27" (1651 mm x 686 mm)
 Weight: 110 lbs (49.9 kg)
 Minimum floor load: 41 lbs/ft² (200.2 kg/m²)
 Water depth: 14" (356 mm)
 Water capacity: 72 gal (272.5 L)
 Cutout: Drop-in, 70" x 34" (1778 mm x 864 mm)
 Electrical component rating: Pump: 120 V, 7.5 A, 60 Hz
 Pump speed: Single
 Minimum flat for door: 2-1/8" (54 mm)

Notes

Measure your actual product for rough-in details. Install this product according to the installation instructions.

The hot water supply should be 70% of the capacity of the bath or greater. Installations will vary.

Provide one grounded electrical outlet within 24" (610 mm) of each component.

Pump must be relocated to custom position at the time of installation. Provide adequate clearance.

If installing a rim-mount faucet, make sure there is no interference above or below the deck before drilling any holes.