

LONDON COLLECTION OFFSET SHOWER DOOR HANDLE

24870618/70624/70818/70824
/71218/71224

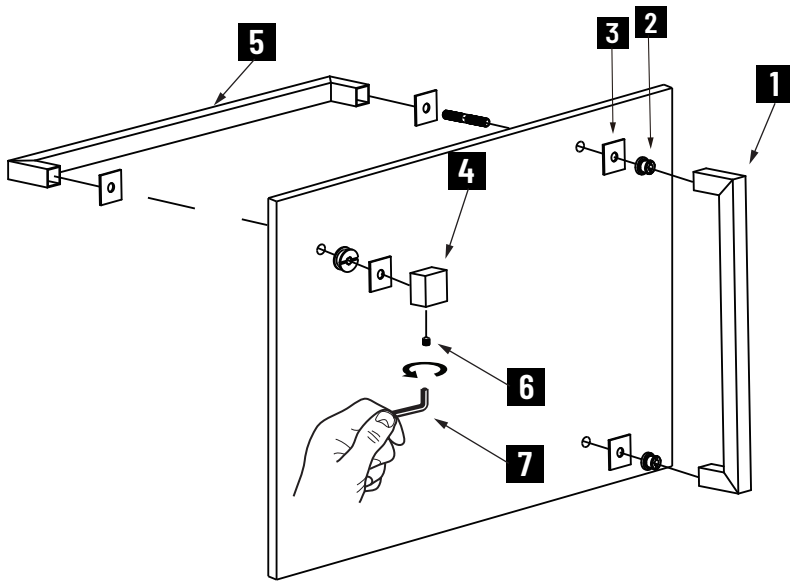

1. Vertical Handle
2. Fixing Bracket x 4
3. Clear Gasket x 4
4. End Cap x 2
5. Horizontal Handle
6. Set Screw M5 x 2
7. Allen Key 2.5mm x 1

GLASS INFO

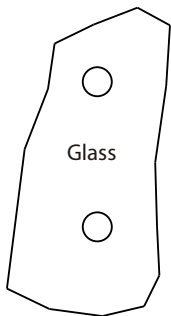

Glass Hole C-C Distance		
A	6"/152mm	6" Shower Door Handle
	8"/203mm	8" Shower Door Handle
	12"/305mm	12" Shower Door Handle
	18"/457mm	18" Shower Door Handle
	24"/610mm	24" Shower Door Handle
B	1/2"(12mm)	Glass Hole Diameter
C	6-12mm	Glass Thickness

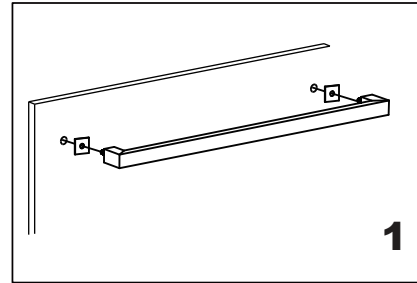

Install the vertical handle (bolt) through the glass holes, make sure the rubber gaskets are between handle & glass.

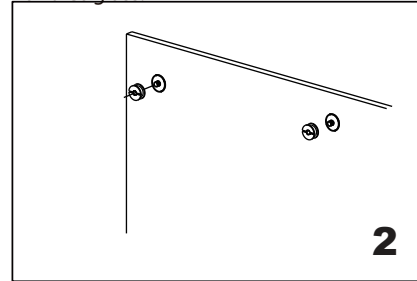

Screw in the fixing brackets into the handle bolts.

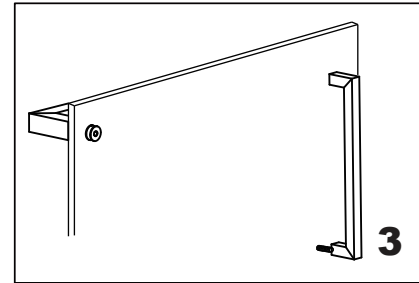

Install the horizontal handle (bolt) through the glass, make sure the set screws holes in the bottom.

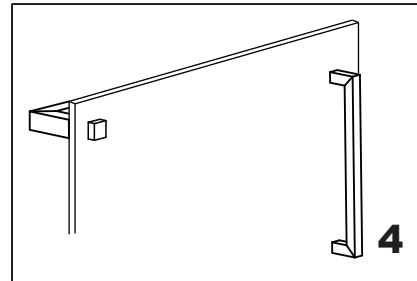

Screw in the bracket onto the bolt fix the backing (end cap) onto the bracket

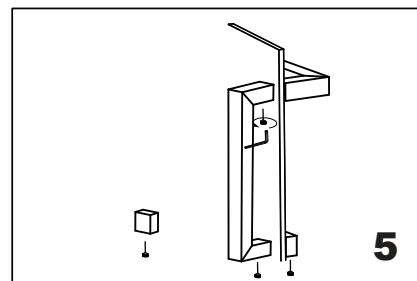

Fix the set screws on the end caps, tighten it to avoid loose from fixing brackets.