

### WIRE BASKETS

#### SOAP BASKET 828011

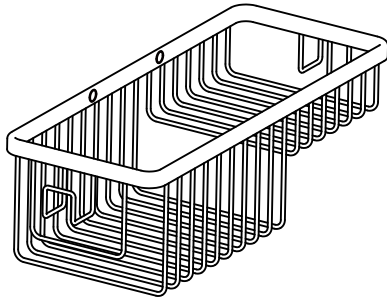

#### Tools required for installation

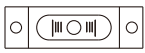

Level

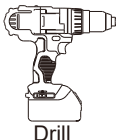

Drill



Pencil

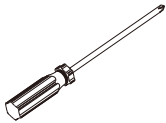

Screwdriver



Hammer

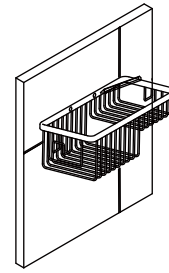

#### Step 1

Position the shower shelf against the wall and mark the holes with pencil.

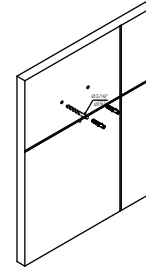

#### Step 2

Predrill 3/16" holes on the wall to fit wall plugs. Insert wall plugs into the wall.

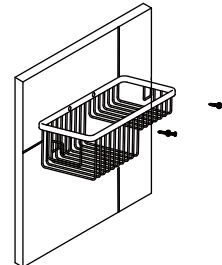

#### Step 3

Install screws into the wall and tighten them, ensure the product is level.

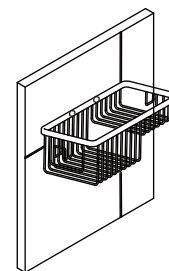

#### Step 4

Install the end caps onto the set screws.