

*BATH MIXING PROGRAM
PROGRAMME DU MITIGEUR POUR LA SALLE DE BAIN
PROGRAMA MEZCLADORES BAÑO*

Art. 43264

Art. 43266

Art. 43268

Art. 43270

Art. 48265

Art. 58263

Art. 58363



Gessi SpA - Parco Gessi

13037 Serravalle Sesia (Vercelli) - Italy

Phone +39 0163 454111 - Facsimile +39 0163 459273

www.gessi.com - gessi@gessi.it

CAUTION - WARNING

- 1 - **WARNING!!** PLEASE TAKE NOTICE THAT the suggested maximum pressure and/or temperature **MUST NEVER BE EXCEEDED**, as it may damage and/or cause ruptures and/or leakages and/or even break the product, and present a potential hazard and danger to safety, health and/or property. Following are the technical data with respect to the installation of Gessi plumbing products.
 - ▶ Working pressure should not be lower than 0,5 bar (7,25 psi) and not be higher than 5 bar (72 Psi). In case of higher working pressure use a pressure reducer valve.
 - ▶ Maximum test installation pressure: 8 bar (116 psi).
 - ▶ Avoid major pressure differences between hot and cold water supply. Differences in pressure, water with high mineral content, and soapy substances can corrode the internal and external parts of the hoses and slowly weaken the materials thereby causing leakage.
 - ▶ Maximum working temperature for Gessi products is 70°C (158 °F).
- 2 - **WARNING!!** PLEASE TAKE NOTICE THAT the product should never be used as a tool, hammer or for any purposes other than the one it has been designed for.
- 3 - **WARNING!!** PLEASE TAKE NOTICE THAT the product should always be installed and tested by a professional plumber.
- 4 - **WARNING!!** For product installation, please refer to the LOCAL PLUMBING CODE.
- 5 - **WARNING!!** PLEASE TAKE NOTICE THAT electric cables should never be attached to the product as they may present a health and safety hazard.
- 6 - **WARNING!!** PLEASE TAKE NOTICE THAT heavy objects should never be placed on or dropped on the product as they may damage the same and cause splinters, which may present a health and safety hazard.
- 7 - **WARNING!!** PLEASE TAKE NOTICE THAT the instructions manual should carefully read before installation and the installation procedure provided therein must be properly followed and complied with.
- 8 - **WARNING!!** PLEASE TAKE NOTICE THAT during installation the use of excessive force should be avoided in order to prevent damage to the product and/or its components and pieces. **NEVER** force a component or piece into another. **NEVER** force screws or over tighten screws.
- 9 - **WARNING!!** No one uses aluminum **FITTINGS** for water connections.

ATTENTION - AVERTISSEMENT

- 1 - **ATTENTION!!** NOUS VOUS PRIONS DE TENIR COMPTE QUE la pression et/ou la température maximum suggérée NE DOIT JAMAIS ETRE DEPASSEE, car elle pourrait abîmer et/ou provoquer des ruptures et/ou des fuites et/ou des pannes du produit et, donc, représenter un risque et danger potentiel pour la sécurité, la santé et/ou les choses. Ci-dessous nous indiquons les données techniques concernant l'installation des produits sanitaires Gessi.
 - ▶ La pression de service ne doit pas être inférieure à 0,5 bar (7,25 psi) et supérieure à 5 bar (72 Psi). En cas de pressions de service plus hautes utiliser une soupape de réduction de la pression.
 - ▶ Pression maximum d'essai à l'installation: 8 bar (116 psi).
 - ▶ Eviter des différences de pression importantes entre l'alimentation de l'eau chaude et celle de l'eau froide. Les différences de pression, l'eau avec une haute teneur minérale et les substances savonnées peuvent corroder les parties internes et externes des flexibles et, lentement, affaiblir les matières en provoquant des fuites.
 - ▶ La température maximum de service pour les produits Gessi est 70°C (158 °F).
- 2 - **ATTENTION!!** NOUS VOUS PRIONS DE TENIR COMPTE QUE le produit ne doit jamais être utilisé comme outil, marteau ou pour tout autre but, autre que celui pour lequel il a été conçu.
- 3 - **ATTENTION!!** NOUS VOUS PRIONS DE TENIR COMPTE QUE le produit doit être toujours installé et testé par un plombier professionnel.
- 4 - **ATTENTION!!** Pour l'installation du produit, référez-vous au LOCAL PLUMBING CODE, s.v.p.
- 5 - **ATTENTION!!** NOUS VOUS PRIONS DE TENIR COMPTE QUE les câbles électriques ne doivent jamais être reliés au produit car ils pourraient représenter un danger pour la sécurité et la santé.
- 6 - **ATTENTION!!** NOUS VOUS PRIONS DE TENIR COMPTE QUE les objets lourds ne doivent jamais être posés ou fait tomber sur le produit, car il peuvent provoquer la projection d'éclats et représenter un danger pour la sécurité et la santé.
- 7 - **ATTENTION!!** NOUS VOUS PRIONS DE TENIR COMPTE QUE le manuel d'instructions doit être lu attentivement avant l'installation et que les procédures d'installation prévues ici doivent être adéquatement suivies et respectées.
- 8 - **ATTENTION!!** NOUS VOUS PRIONS DE TENIR COMPTE QUE, pendant l'installation, il faut éviter l'emploi d'une force excessive de sorte à éviter des dommages au produit et/ou à ses composants et pièces. NE JAMAIS forcer un composant ou une pièce à l'intérieur d'une autre. NE JAMAIS forcer les vis et ne pas les serrer excessivement.
- 9 - **ATTENTION!!** Ne pas utiliser raccords de aluminium pour les connexions de l'eau.

CUIDADO - ADVERTENCIA

- 1 - ***¡CUIDADO!!*** LES ROGAMOS QUE TENGAN EN CUENTA QUE NUNCA la presión y/o la temperatura máxima aconsejada NO TIENE QUE SER SUPERADA, ya que podría dañar y/o causar rupturas y/o pérdidas y/o averías del producto y, por lo tanto, representar un riesgo y un peligro potencial para la seguridad, la salud y/o la propiedad. A continuación Les proporcionamos los datos técnicos relativos a la instalación de los productos de grifería Gessi.
 - ▶ La presión de ejercicio no tiene que ser inferior a 0,5 bar (7,25 psi) y superior a 5 bar (72 Psi). En caso de presiones de ejercicio mayores, utilicen una válvula de reducción de la presión.
 - ▶ Presión máxima de ensayo durante la instalación: 8 bar (116 psi).
 - ▶ Eviten grandes diferencias de presión entre la alimentación del agua fría y aquella del agua caliente. Las diferencias de presión, el agua con un alto contenido mineral y las sustancias jabonosas pueden corroer las partes interiores y exteriores de los flexos y, lentamente, e, lentamente, debilitar los materiales causando pérdidas.
 - ▶ La temperatura máxima de ejercicio para los productos Gessi es 70°C (158 °F).
- 2 - ***¡CUIDADO!!*** LES ROGAMOS QUE TENGAN EN CUENTA QUE nunca el producto no tiene que ser utilizado como en lugar de herramienta, martillos o para finalidades diferentes de aquellas para las cuales ha sido diseñado.
- 3 - ***¡CUIDADO!!*** LES ROGAMOS QUE TENGAN EN CUENTA QUE el producto tiene que ser instalado y ensayado siempre por un fontanero profesional.
- 4 - ***¡CUIDADO!!*** Para la instalación del producto Les rogamos que contacten con el LOCAL PLUMBING CODE.
- 5 - ***¡CUIDADO!!*** LES ROGAMOS QUE TENGAN EN CUENTA QUE nunca los cables eléctricos no tiene que ser conectado al producto ya que podrían representar un peligro para la seguridad y la salud.
- 6 - ***¡CUIDADO!!*** LES ROGAMOS QUE TENGAN EN CUENTA QUE nunca objetos pesados no tienen que ser apoyados o dejados caer sobre el producto ya que podrían causar la proyección de astillas y representar un peligro para la seguridad y la salud.
- 7 - ***¡CUIDADO!!*** LES ROGAMOS QUE TENGAN EN CUENTA QUE el manual de instrucción tiene que ser leído con cuidado antes de la instalación y que hay que cumplir adecuadamente con los procedimientos de instalación proporcionados.
- 8 - ***¡CUIDADO!!*** LES ROGAMOS QUE TENGAN EN CUENTA QUE, durante la instalación, hay que evitar el uso de una fuerza excesiva de manera que se puedan evitar daños del producto y/o componentes y piezas. NO fuercen NUNCA un componente o una pieza, la una dentro de la otra. NO fuercen NUNCA los tornillos y no los cierren excesivamente.
- 9 - ***¡CUIDADO!!*** No utilicen ACCESORIOS de aluminio para las conexiones del agua.



Art. 43264

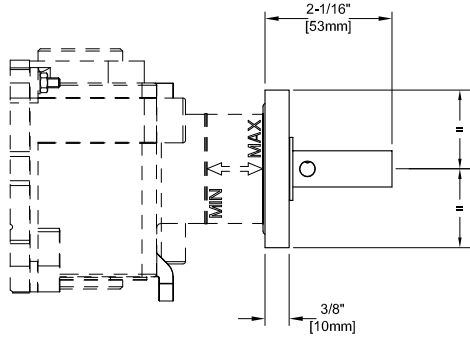
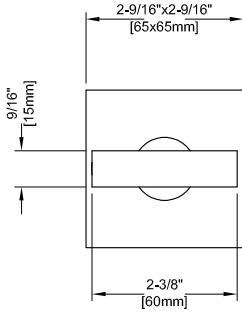

Art. 43266

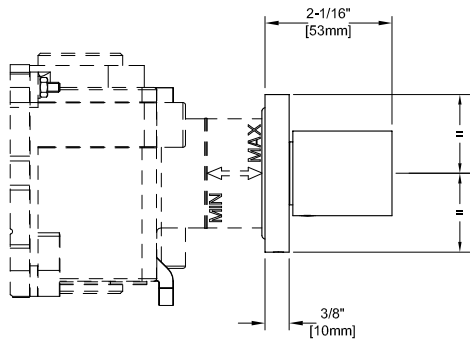
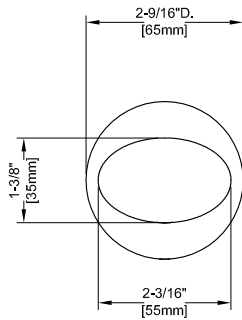



Art. 43268

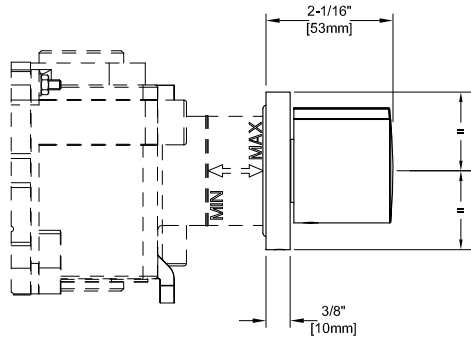
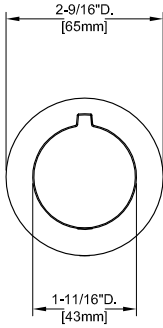

Art. 43270

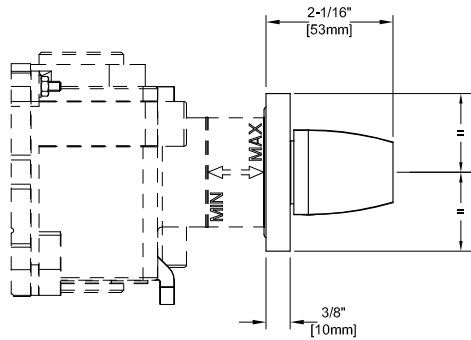
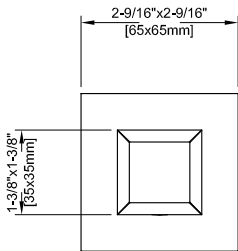



Art. 48265

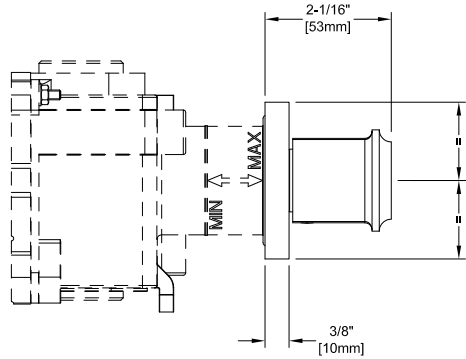
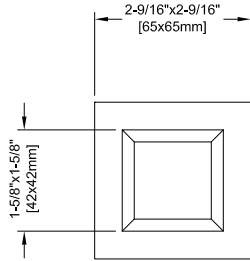

Art. 58263

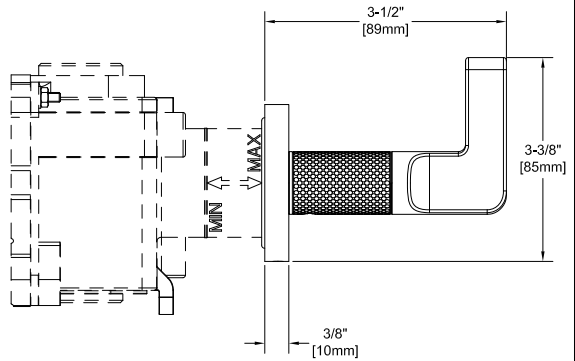
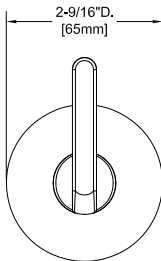



Art. 58363

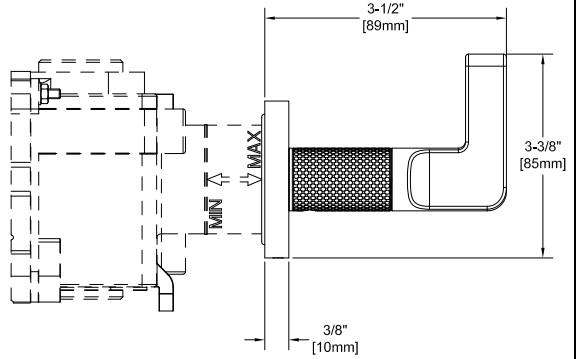
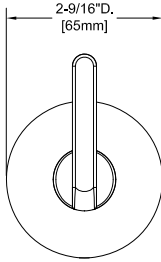



Before installation and setting to work

Attention! The feeding pipes have to be rinsed carefully before the installation of the device so that there won't remain shavings, sealing or hemp residues, or other impurities inside the pipes. Through pipes not thoroughly rinsed or through the general water network, in the device foreign bodies can enter that could damage gaskets /o-ring. So filters should be installed also on the general system.

TECHNICAL DATA

- Minimum working pressure 0,5 bar
- Maximum working pressure 5 bar
- Recommended working pressure 3 bar (in case of water pressure higher than 5 bar it is recommended to install pressure reducers)

Avant l'installation et la mise en fonction

Attention! Les tuyaux d'alimentation doivent être rincés avec soin avant l'installation du dispositif, de sorte que ils ne restent pas de copeaux, des restes de soudage ou de chanvre, ou d'autres impuretés à l'intérieur des tuyaux. A travers les conduites non rincées à fond ou à travers le réseau hydrique général, dans le dispositif peuvent entrer des corps étrangers à même de détériorer les gaines/o-ring. On recommande ainsi d'installer des filtres également sur le système général.

DONNÉES TECHNIQUES

- Pression minimum d'exercice 0,5 bar
- Pression maximum d'exercice 5 bar
- Pression d'exercice conseillée 3 bar (en cas de pression de l'eau supérieure aux 5 bar nous conseillons l'installation de réducteurs de pression)

Antes de la instalación y la puesta en función

¡Cuidado! Los tubos de alimentación tienen que ser enjuagados escrupulosamente antes de instalar el dispositivo de manera que no haya virutas, residuos de soldadura o cáñamo u otras impurezas al interior de los tubos. A través de los tubos no perfectamente enjuagados o de la red hídrica general pueden entrar en el dispositivo unos cuerpos extraños que pueden dañar guarniciones/o-rings. Les recomendamos por lo tanto que instalen los filtros en la planta general también.

DATOS TÉCNICOS

- Presión mínima de ejercicio 0,5 bar
- Presión máxima de ejercicio 5 bar
- Presión de ejercicio aconsejada 3 bar (en caso de presión del agua superior a los 5 bar, les aconsejamos instalar unos reductores de presión)

Pressure [bar]	Outlet [l/min]				
	1				
0.5	17				
1	24				
2	31.5				
3	38.5				
4	43.5				
5	48.5				

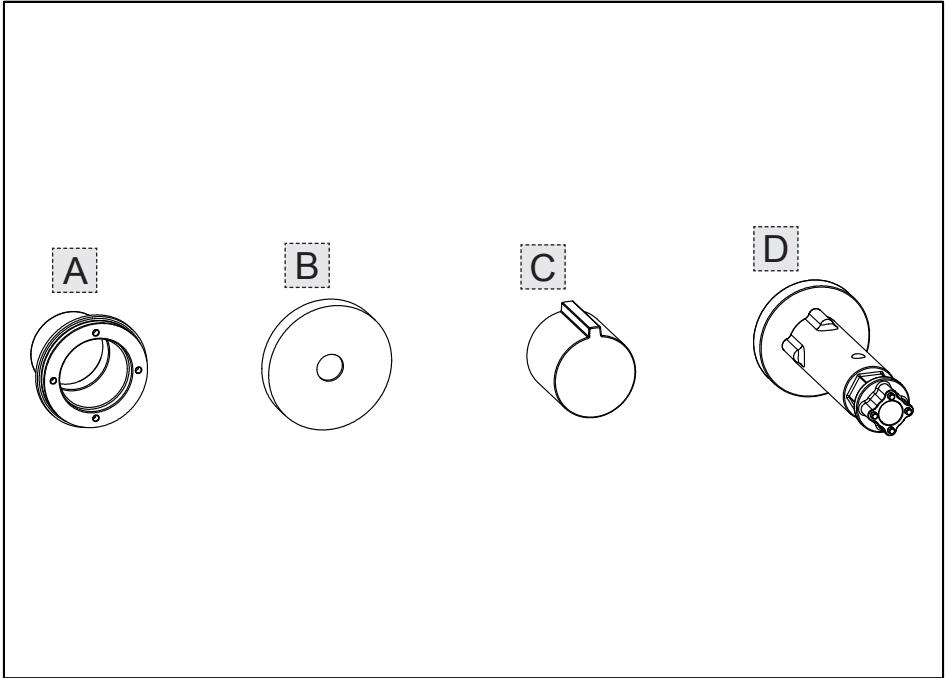

Package content:

- C - Bush for plate fastening
- E - Finish plate
- G - Control handle
- L - Installation wrenches

Contenu de l'emballage:

- C - Douille pour fixation plaque
- E - Plaque en finition
- G - Poignée de commande
- L - Clés pour l'installation

Contenido de la caja:

- C - Buje para fijación placa
- E - Placa de acabado
- G - Maneta de mando
- L - Llaves de instalación



Fig. 1

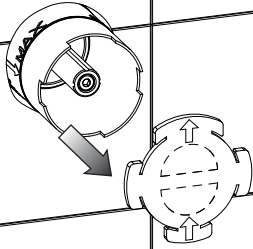

Fig. 2

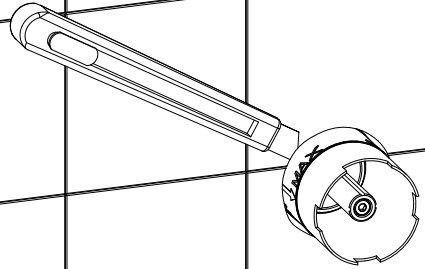

Fig. 3

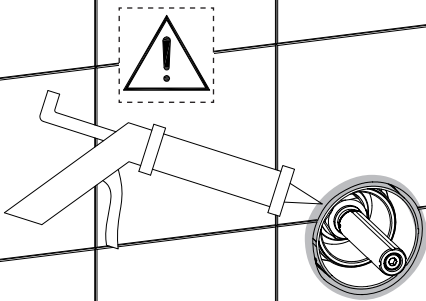



Fig. 4

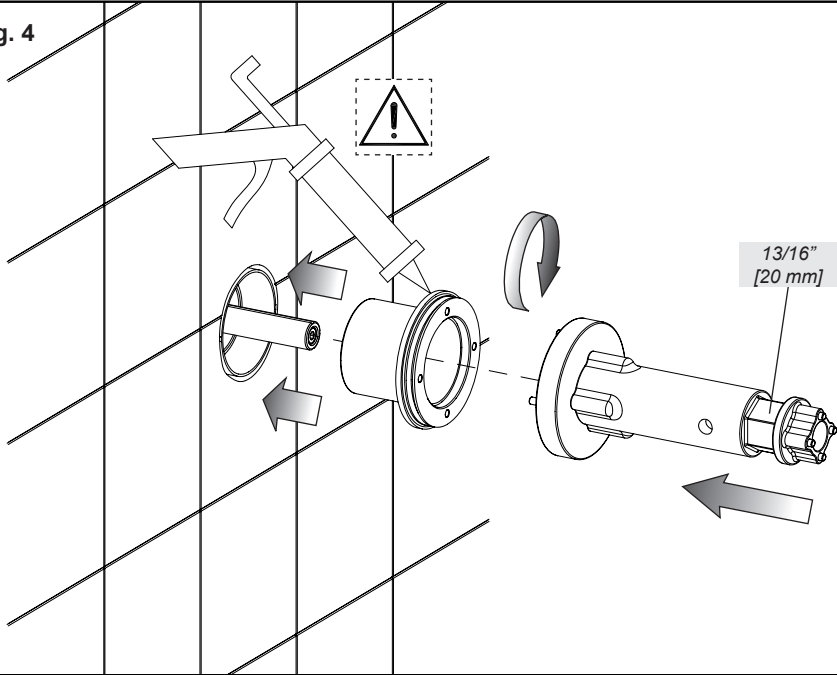

Fig. 5

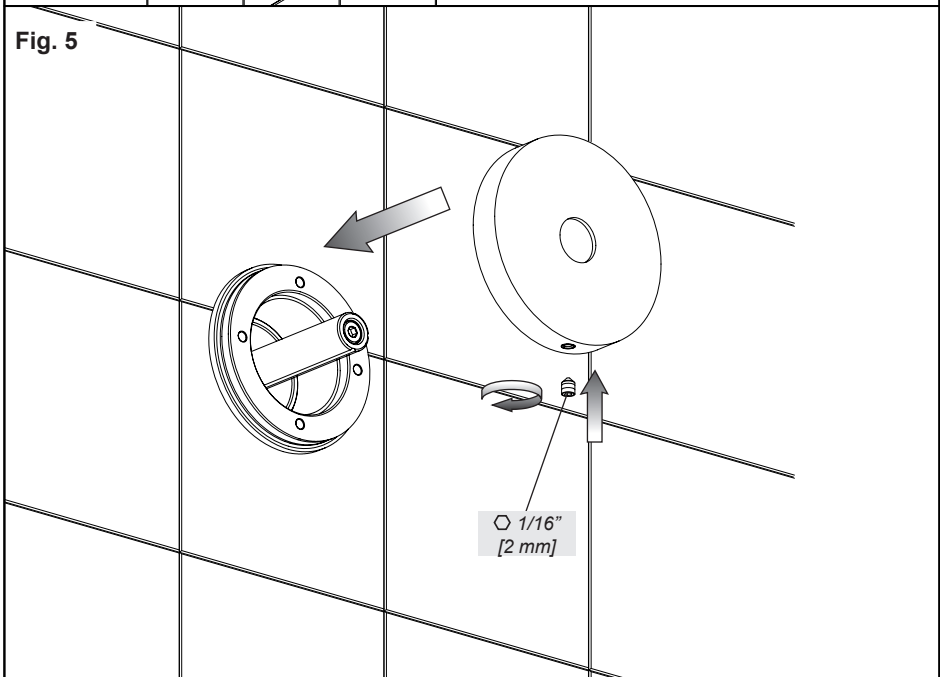



Fig. 6

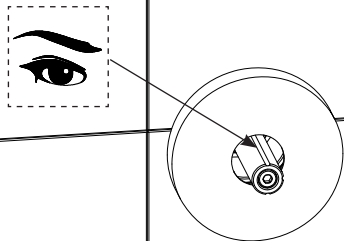

Fig. 7

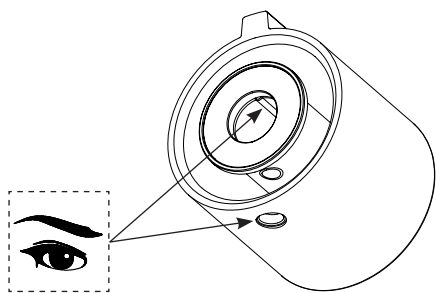
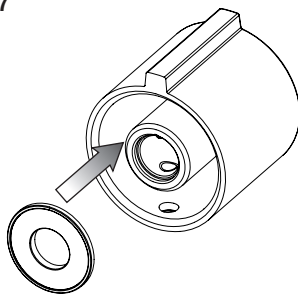
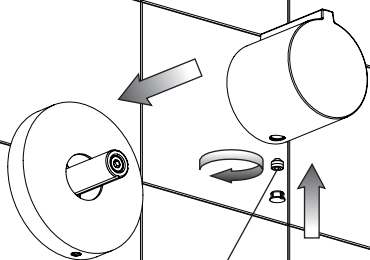
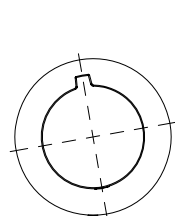
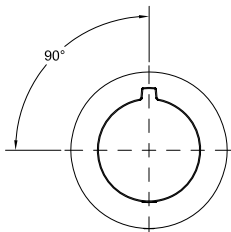

Fig. 8



Ø 1/8" [2,5 mm]

Fig. 9



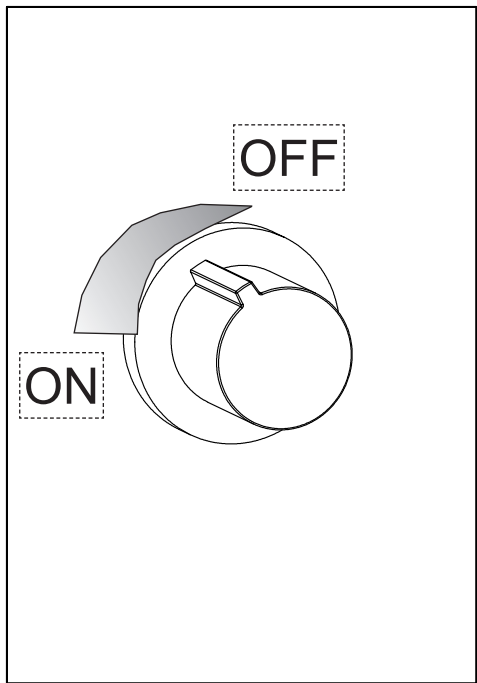



MANUTENZIONE

- Nel caso sia necessario sostituire uno o più componenti, contattare un rivenditore autorizzato o visitare il sito WWW.GESSI.COM
- Affidare la manutenzione del prodotto a personale qualificato

MAINTENANCE

- Should it be necessary to replace one or more components, contact an authorized retailer or visit WWW.GESSI.COM
- Product maintenance should be made only by qualified staff

ENTRETIEN

- S'il est nécessaire de remplacer un ou plusieurs composants, contacter un centre autorisé ou visiter le site WWW.GESSI.COM
- L'entretien du produit ne doit être effectué que par du personnel qualifié

WARTUNG

- Falls das Auswechseln von einem oder mehreren Bestandteilen erforderlich wird, kontaktieren Sie bitte einen autorisierten Fachhandel oder besuchen Sie unsere Website unter WWW.GESSI.COM
- Die Instandhaltung des Produktes sollte nur qualifiziertem Personal anvertraut werden.

MANUTENCIÓN

- En el caso de que sea necesario remplazar uno o más componentes, contacten con un revendedor autorizado o visiten el sitio WWW.GESSI.COM
- Encarguen sólo a personal calificado para el mantenimiento del producto

ОБСЛУЖИВАНИЕ

- В случае если будет необходимо заменить один или несколько компонентов, обратитесь к авторизованному дистрибьютору или посетите веб-сайт WWW.GESSI.COM
- Обслуживание изделия должен выполнить квалифицированный персонал.

ΣΥΝΤΗΡΗΣΗ

- Σε περίπτωση που είναι απαραίτητο να αντικαταστήσετε ένα ή περισσότερα εξαρτήματα, επικοινωνήστε με ένα εξουσιοδοτημένο κατάστημα πώλησης ή επισκεφθείτε τον ιστότοπο WWW.GESSI.COM
- Εμπιστευθείτε τη συντήρηση του προϊόντος σε διαπιστευμένο προσωπικό

保养

- 若需替换一个或者多个部件，请联系授权分销商或浏览WWW.GESSI.COM网站
- 请让合格人士负责产品保养工作



HEADVALVE REPLACEMENT - SUBSTITUTION DE LA TÊTE - SUSTITUCIÓN DE LA MONTURA

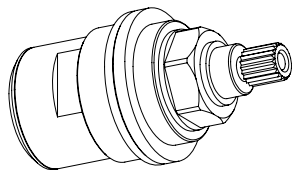

Fig. 10

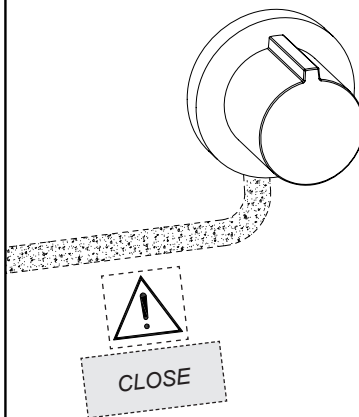

Fig. 11

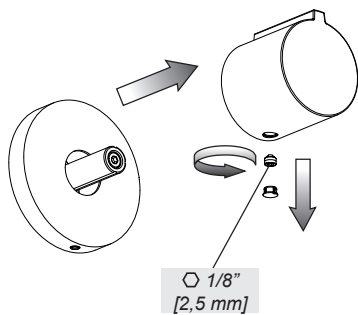
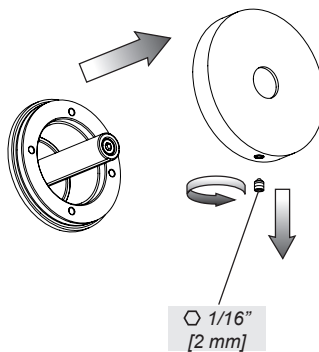

Fig. 12





HEADVALVE REPLACEMENT - SUBSTITUTION DE LA TÊTE - SUSTITUCIÓN DE LA MONTURA

Fig. 13

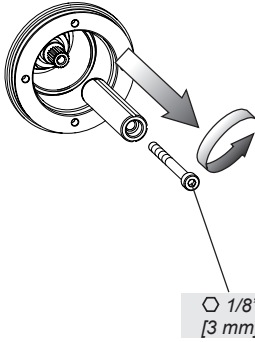
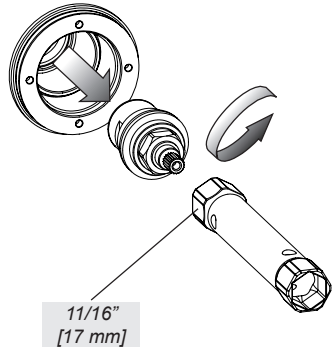

Fig. 14



Not supplied
Non fournie
Excluida del suministro



ALIGNMENT OF CONTROL HANDLES - ALIENEMENT DES POIGNÉES DE COMMANDE -
ALINEACIÓN DE LAS MANETAS DE MANDO

Fig. 15

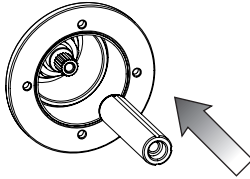

Fig. 16

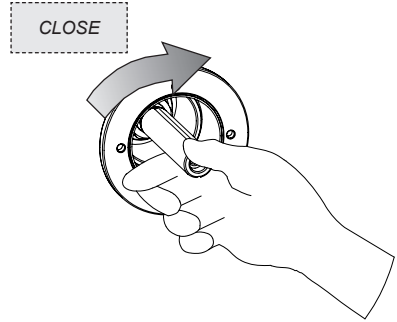

Fig. 17

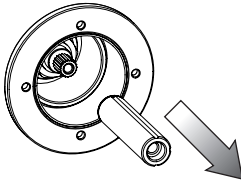

Fig. 18

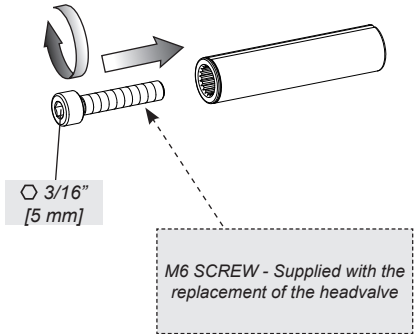

Fig. 19

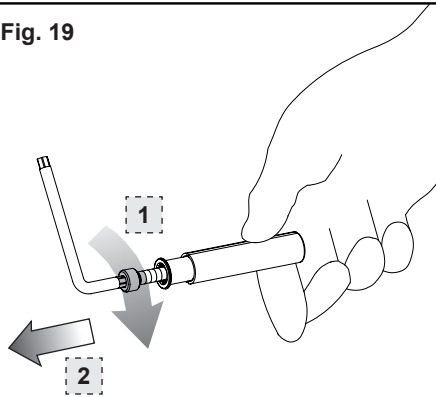
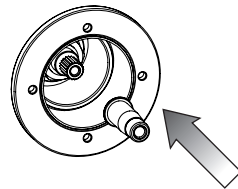

Fig. 20





ALIGNMENT OF CONTROL HANDLES - ALIENEMENT DES POIGNÉES DE COMMANDE -
ALINEACIÓN DE LAS MANETAS DE MANDO

Fig. 21

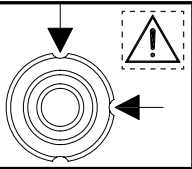
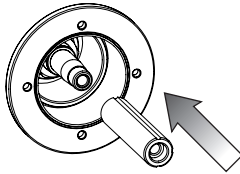
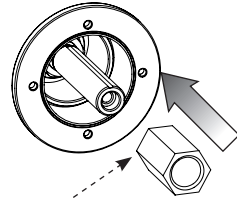

Fig. 22



Supplied with the replacement
of the headvalve

Fig. 23

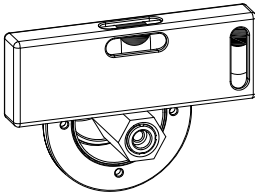
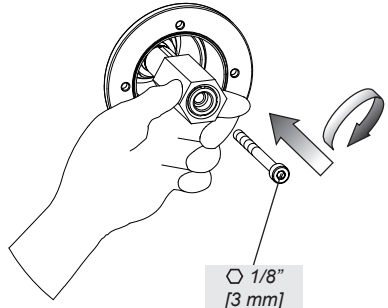

Fig. 24



⊕ 1/8"
[3 mm]

Fig. 25 - A

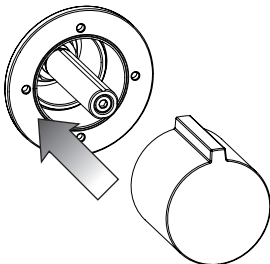
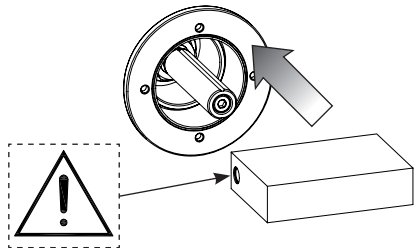

Fig. 25 - B





ALIGNMENT OF CONTROL HANDLES - ALIGNEMENT DES POIGNÉES DE COMMANDE -
ALINEACIÓN DE LAS MANETAS DE MANDO

Fig. 26

OK

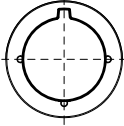

NO

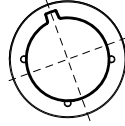

NO

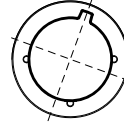

Repeat these steps until reaching proper alignment of the handle, and then remove it to allow the installation of external parts.

Repeat these steps until reaching proper alignment of the handle, and then remove it to allow the installation of external parts.

Repitan estas operaciones hasta obtener la correcta alineación de la maneta, finalmente remuévanla para permitir la instalación de las partes externas.